

Model# IOL405BK-A

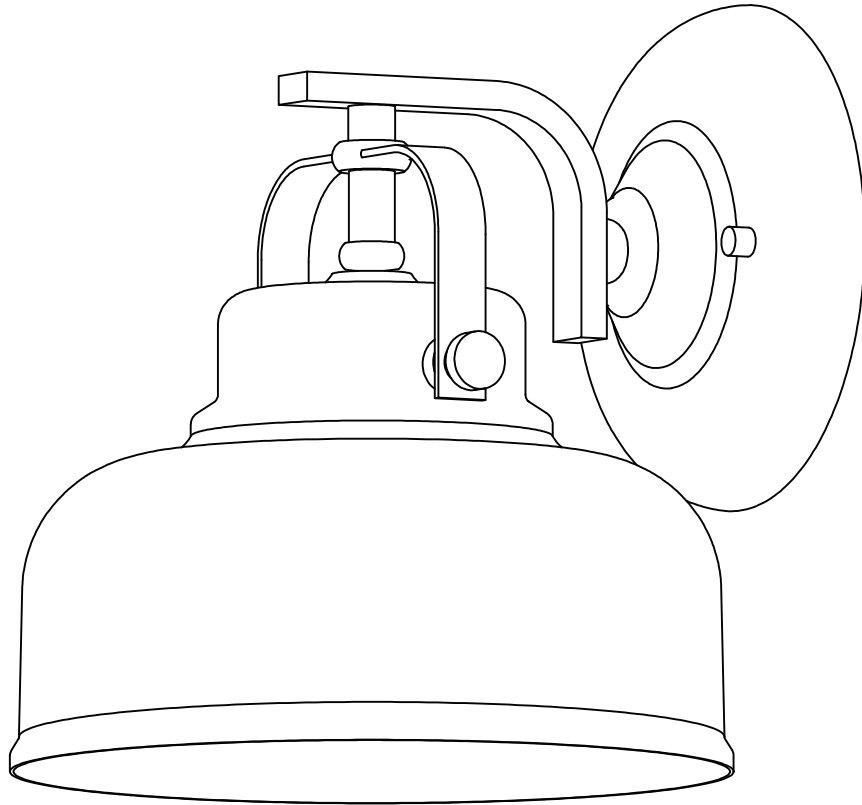









Welcome Guide

Model# IOL405BK-A

Contents:

Before getting started, ensure the package contains the following components:

	Part		Qty
1	Part 1 (ex. Wire Nuts)		3
2	Part 2 (ex. Easy Connect™ Mounting Bracket)		1
3	Part 3 (ex. Star Washers)		2
4	Part 4 (ex. Cap Nuts)		2
5	Part 5 (ex. Fixture)		1
6	Part 6 (ex. White wire)		1
7	Part 7 (ex. Black wire)		1
8	Part 8 (ex. Ground wire)		1
9	Part 9 (ex. Bulb)		1

Assembly Instructions

Tools And Materials Required



Wiring supplies as
required by local
electrical code

Step 1: Attach Easy Connect™ mounting bracket (2) to electrical box with electrical box screws (not included).

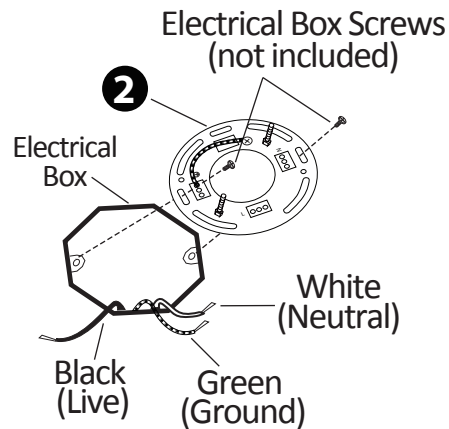

Step 2:

Option 1- Connect (push) electrical wires from electrical box (house wiring) into correct inserts.

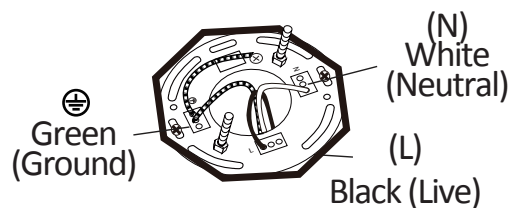

Option 2 - multiple electrical box wires

For multiple green (ground), black (live) and white (neutral) wires joined in the electrical box (house wiring), attach a single “green” (8), “black” (7) and “white” (6) jumper wire before connecting. Strip 7mm from the 6” jumper wires supplied. Then connect (push) wires into the correct inserts.

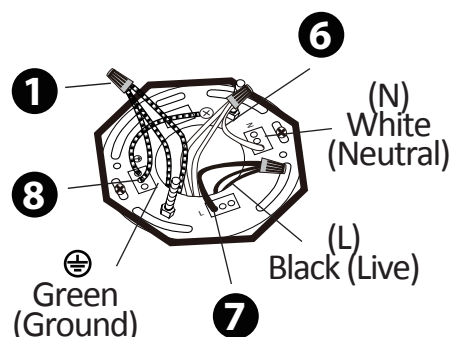

Assembly Instructions

Step 3: Connect (push) electrical wires from fixture (5) into correct inserts.

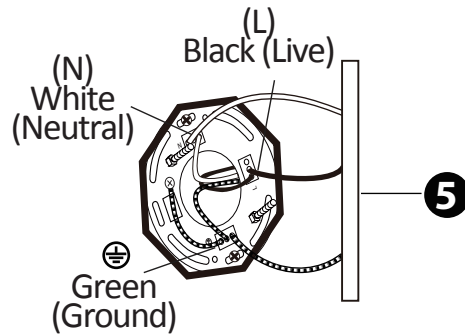

Step 4: Tuck electrical wires into electrical box and position fixture (5) over studs on mounting bracket (2) assembly. Secure fixture (5) in place with star washers (3) and cap nuts (4).

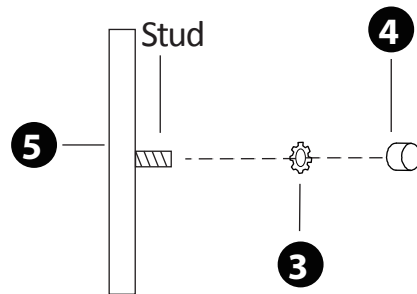

Step 5: Install specified bulb (9) type and wattage.

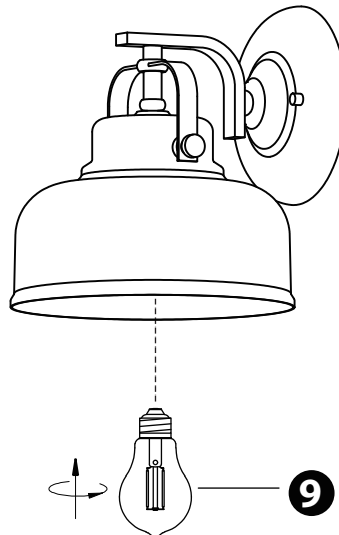

Assembly Instructions

Step 6: After Installation, seal around the top and side perimeter between the fixture and the wall surface with weather resistant caulking. The bottom should be left un-caulked to prevent moisture build-up. Apply a small amount of weather resistant caulking around the side perimeter between the cap nut and mounting plate.

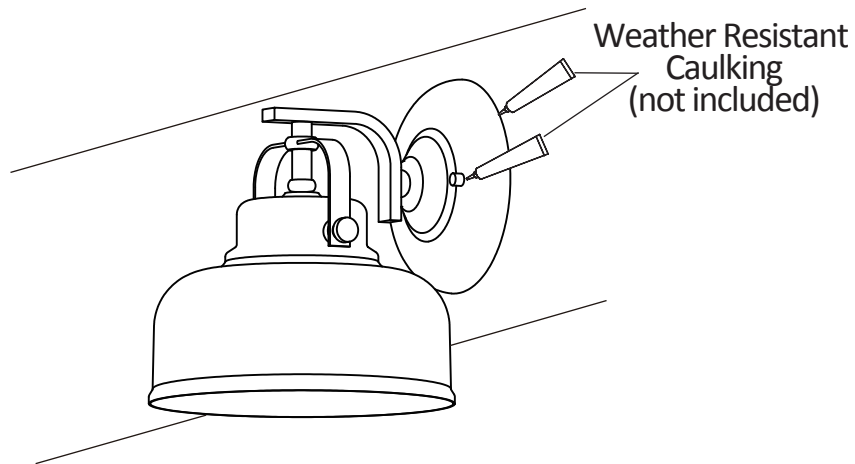

Cleaning and Maintenance

- To clean, turn off and wipe with a damp, non-abrasive cloth.
- When cleaning, use only a soft brush or lint free cloth to avoid scratching the finish.
- Abrasive cleaning agents are not required and should be avoided to prevent damage to finish.

Safety

- Turn off electrical power before starting installation of light fixture.
- This product must be installed in accordance with the applicable installation code by a person familiar with the construction and operation of the product and the hazards involved.