

USER'S MANUAL

VKP Series

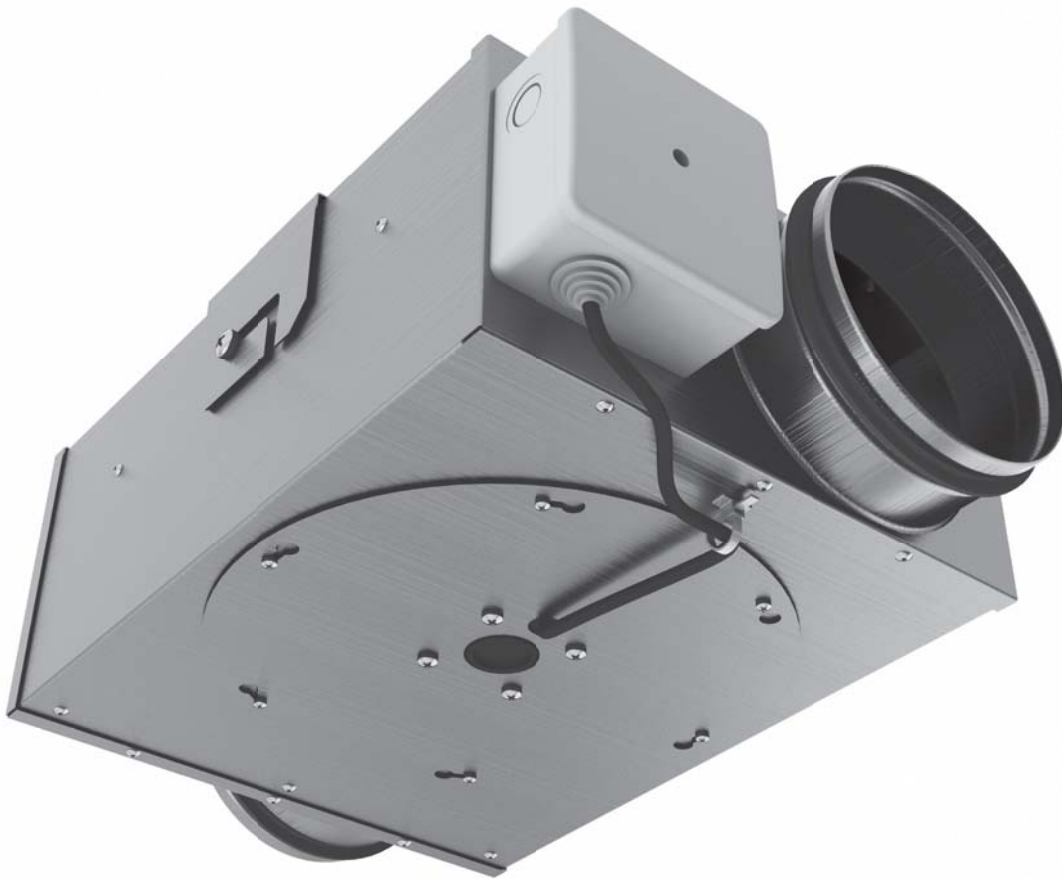

INLINE FAN

CONTENTS

Safety requirements	3
Introduction	5
Use	5
Delivery set	5
Designation key	5
Technical data	5
Design and operating logic	8
Mounting and set-up	8
Connection to power mains	11
Maintenance	13
Troubleshooting	14
Storage and transportation rules	14
Manufacturer's warranty	15
Acceptance certificate	16
Seller's information	16
Connection Certificate	16
Warranty Card	17

SAFETY REQUIREMENTS

- Read the user's manual carefully prior to installation and operation of the inline fan, hereinafter the fan.
- Installation and operation of the fan shall be performed in accordance with the present user's manual as well as the provisions of all the applicable local and national construction, electrical and technical codes and standards.
- The warnings contained in the present user's manual must be considered most seriously since they contain vital personal safety information.
- Failure to follow the safety regulations may result in an injury or the fan damage.
- Read the manual carefully and keep it as long as you use the fan.
- While transferring the fan control the user's manual must be turned over to the receiving operator.

Symbol legend used in the manual:





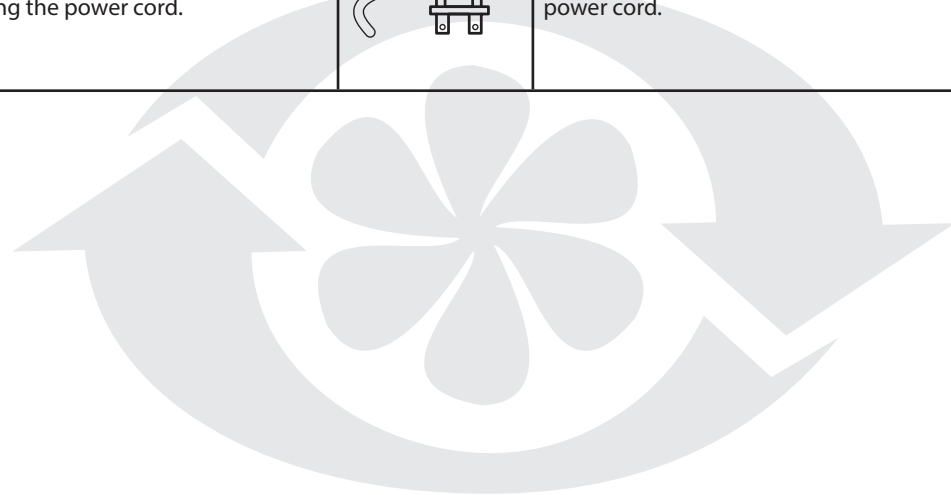

	WARNING!
	DO NOT!

FAN MOUNTING SAFETY PRECAUTIONS

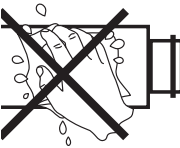
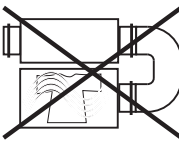
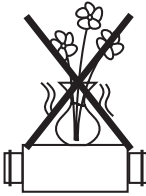
	The fan must be disconnected from the power supply prior to every installation or repair operation.		The fan must be grounded!
	The fan must not be operated outside the temperature range stated in the user's manual or in aggressive or explosive environments.		Do not use damaged equipment or conductors to connect the fan to power mains.
	While installing the fan follow the safety regulations specific to the use of electric tools.		Unpack the fan with care.
	Do not change the power cord length at your own discretion. Do not bend the power cord. Avoid damaging the power cord.		Do not position any heating devices or other equipment in close proximity to the fan power cord.

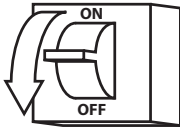
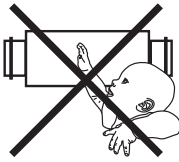

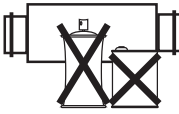
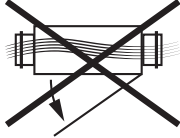
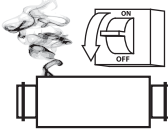
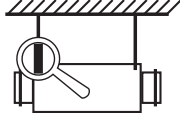
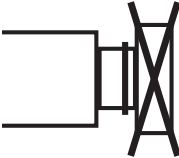
FAN OPERATING SAFETY PRECAUTIONS

	<p>Do not touch the controller or the remote control with wet hands. Do not carry out the fan maintenance with wet hands.</p>		<p>Do not wash the fan with water. Protect the fan electric parts from water ingress.</p>
	<p>Use the fan only as intended by the manufacturer. Do not connect any drying machines or other similar equipment to the fan or the ventilation circuit.</p>		<p>Do not put any water containers on the fan, for example, flower vases.</p>
	<p>Do not sit or put objects on the fan.</p>		<p>Disconnect the fan from power supply before maintenance.</p>
	<p>Do not let children operate the fan.</p>		<p>Do not damage the power cable while operating the fan. Do not put any objects on the power cable.</p>
	<p>Keep explosive and inflammable products away of the fan.</p>		<p>Do not open the operating fan.</p>
	<p>In case of unusual sounds, smoke disconnect the fan from power supply and contact the service centre.</p>		<p>In case of continuous fan operation check the mounting reliability periodically.</p>
	<p>Do not block the air duct when the fan is on.</p>		<p>Do not let air flow from the fan be directed to the open flame devices or candles.</p>

INTRODUCTION

This user's manual includes technical description, operation, installation and mounting guidelines, technical data for the inline fan VKP 80 mini...VKP 100/100x6 mini; VKP 100...VKP 160, hereinafter the fan.

USE

The centrifugal inline fans are designed for supply and extract ventilation of small residential, public and industrial premises with limited mounting space. The fans are compatible with round air ducts Ø 100, 125, 150 and 160 mm and are constructed for ceiling or wall mounting.

The fan is rated for continuous operation always connected to power mains.

The fan is a complete unit and is not designed for separate operation.

Transported air must not contain any flammable or explosive mixtures, evaporation of chemicals, coarse dust, soot and oil particles, sticky substances, fibrous materials, pathogens or any other harmful substances.



THE FAN IS NOT INTENDED TO BE USED BY CHILDREN, PHYSICALLY OR MENTALLY DISABLED PERSONS, PERSONS WITH SENSORY DISORDER, PERSONS WITH NO APPROPRIATE QUALIFICATION. ANY OPERATIONS WITH THE FAN MUST BE PERFORMED ONLY AFTER THE APPROPRIATE SAFETY BRIEFING. THE FAN INSTALLATION SITES MUST PREVENT ACCESS BY UNATTENDED CHILDREN.

DELIVERY SET

- Fan - 1 item;
- Fixing bracket - 1 item;
- User's manual - 1 item;
- Packing box - 1 item.

DESIGNATION KEY

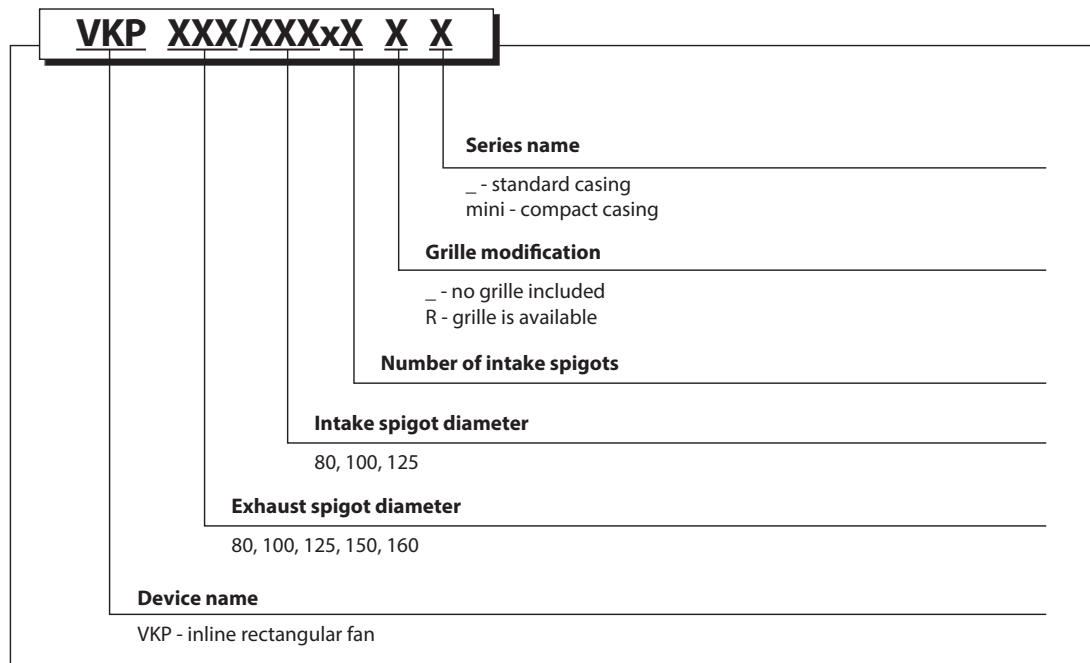

TECHNICAL DATA

The fan is designed for indoor application with the ambient temperature ranging from 0°C up to +45°C and relative humidity up to 80% (at +25 °C).

Ingress Protection (IP) rating from solid objects and liquids IP X4.

The fan is classified as a class I electric appliance.

The main overall and connection dimensions, outer view and technical data are shown in fig. 1 and in table 1 and 2.

The fan design is regularly improved, so some models may slightly differ from those ones described in this manual.

Table 1. Technical data

Fan type	Speed	Supply Voltage, 50 Hz [V]	Power [W]	Current consumption [A]	Max. Air Capacity [m ³ /h]	RPM [min ⁻¹]	Noise Level, 3 m [dBA]	Max. Transported Air Temperature [°C]
VKP 80 mini	1	230	20	0,32	88	1400	32	50
	2		26	0,34	130	1800	35	
	3		45	0,4	162	2600	43	
VKP 80 P mini	1	230	20	0,32	88	1400	32	
	2		26	0,34	130	1800	35	
	3		45	0,4	162	2600	43	
VKP 80/80x2 mini	1	230	20	0,32	88	1400	32	
	2		26	0,34	130	1800	35	
	3		45	0,4	162	2600	43	
VKP 80/80x4 mini	1	230	20	0,32	88	1400	32	
	2		26	0,34	130	1800	35	
	3		45	0,4	162	2600	43	
VKP 80/80x5 mini	1	230	20	0,32	88	1400	32	
	2		26	0,34	130	1800	35	
	3		45	0,4	162	2600	43	
VKP 80/80x6 mini	1	230	20	0,32	88	1400	32	
	2		26	0,34	130	1800	35	
	3		45	0,4	162	2600	43	
VKP 100 mini	1	230	20	0,32	97	1400	33	
	2		26	0,34	138	1800	36	
	3		45	0,4	176	2600	44	
VKP 100 P mini	1	230	20	0,32	97	1400	33	
	2		26	0,34	138	1800	36	
	3		45	0,4	176	2600	44	
VKP 100/80x2 mini	1	230	20	0,32	97	1400	33	
	2		26	0,34	138	1800	36	
	3		45	0,4	176	2600	44	
VKP 100/80x4 mini	1	230	20	0,32	97	1400	33	
	2		26	0,34	138	1800	36	
	3		45	0,4	176	2600	44	
VKP 100/80x5 mini	1	230	20	0,32	97	1400	33	
	2		26	0,34	138	1800	36	
	3		45	0,4	176	2600	44	
VKP 100/80x6 mini	1	230	20	0,32	97	1400	33	
	2		26	0,34	138	1800	36	
	3		45	0,4	176	2600	44	
VKP 100/100x2 mini	1	230	20	0,32	97	1400	33	
	2		26	0,34	138	1800	36	
	3		45	0,4	176	2600	44	
VKP 100/100x4 mini	1	230	20	0,32	97	1400	33	
	2		26	0,34	138	1800	36	
	3		45	0,4	176	2600	44	
VKP 100/100x5 mini	1	230	20	0,32	97	1400	33	
	2		26	0,34	138	1800	36	
	3		45	0,4	176	2600	44	
VKP 100/100x6 mini	1	230	20	0,32	97	1400	33	
	2		26	0,34	138	1800	36	
	3		45	0,4	176	2600	44	
VKP 100	1	230	58	0,26	240	2500	47	-25...+50
VKP 125	1	230	58	0,26	340	2500	48	
VKP 125/100x2	1	230	58	0,26	340	2500	48	
VKP 125/100x4	1	230	58	0,26	340	2500	48	
VKP 150	1	230	85	0,38	553	2600	50	-25...+40
VKP 150/125x2	1	230	85	0,38	553	2600	50	
VKP 160	1	230	85	0,38	553	2600	50	

Table 2. Dimensions

Fan type	Dimensions [mm]								Weight [kg]	Figure
	ØD	ØD1	B	H	H1	L	L1	L2		
VKP 80 mini	79	79	252	90	-	351	-	253	3,2	
VKP 100 mini	99	99	252	110	-	351	-	253	3,2	
VKP 100	99	99	252	133	-	420	-	321	4,5	
VKP 125	124	124	252	133	-	420	-	321	4,5	
VKP 150	149	149	300	170	-	480	-	382	5,4	
VKP 160	159	159	300	170	-	480	-	382	5,5	
VKP 80 R mini	79	-	252	90	126	-	297	253	3,1	
VKP 100 R mini	99	-	252	90	144	-	297	253	3,1	
VKP 80/80x2 mini	79	79	252	90	-	351	-	253	3,1	
VKP 100/80x2 mini	99	79	252	110	-	351	-	253	3,1	
VKP 100/100x2 mini	99	99	252	110	-	351	-	253	3,1	
VKP 125/100x2	124	99	252	133	-	420	-	321	4,5	
VKP 150/125x2	149	124	300	170	-	480	-	382	5,5	
VKP 80/80x4 mini	79	79	252	90	136	-	297	253	3,4	
VKP 100/80x4 mini	99	79	252	110	166	-	297	253	3,4	
VKP 100/100x4 mini	99	99	252	110	166	-	297	253	3,4	
VKP 125/100x4	124	99	252	133	191	-	297	321	5,0	
VKP 80/80x5 mini	79	79	252	90	136	351	-	253	3,5	
VKP 100/80x5 mini	99	79	252	110	166	351	-	253	3,7	
VKP 100/100x5 mini	99	99	252	110	166	351	-	253	3,5	
VKP 80/80x6 mini	79	79	252	90	136	351	-	253	3,6	
VKP 100/80x6 mini	99	79	252	110	166	351	-	253	3,6	
VKP 100/100x6 mini	99	99	252	110	166	351	-	253	3,6	

DESIGN AND OPERATING LOGIC

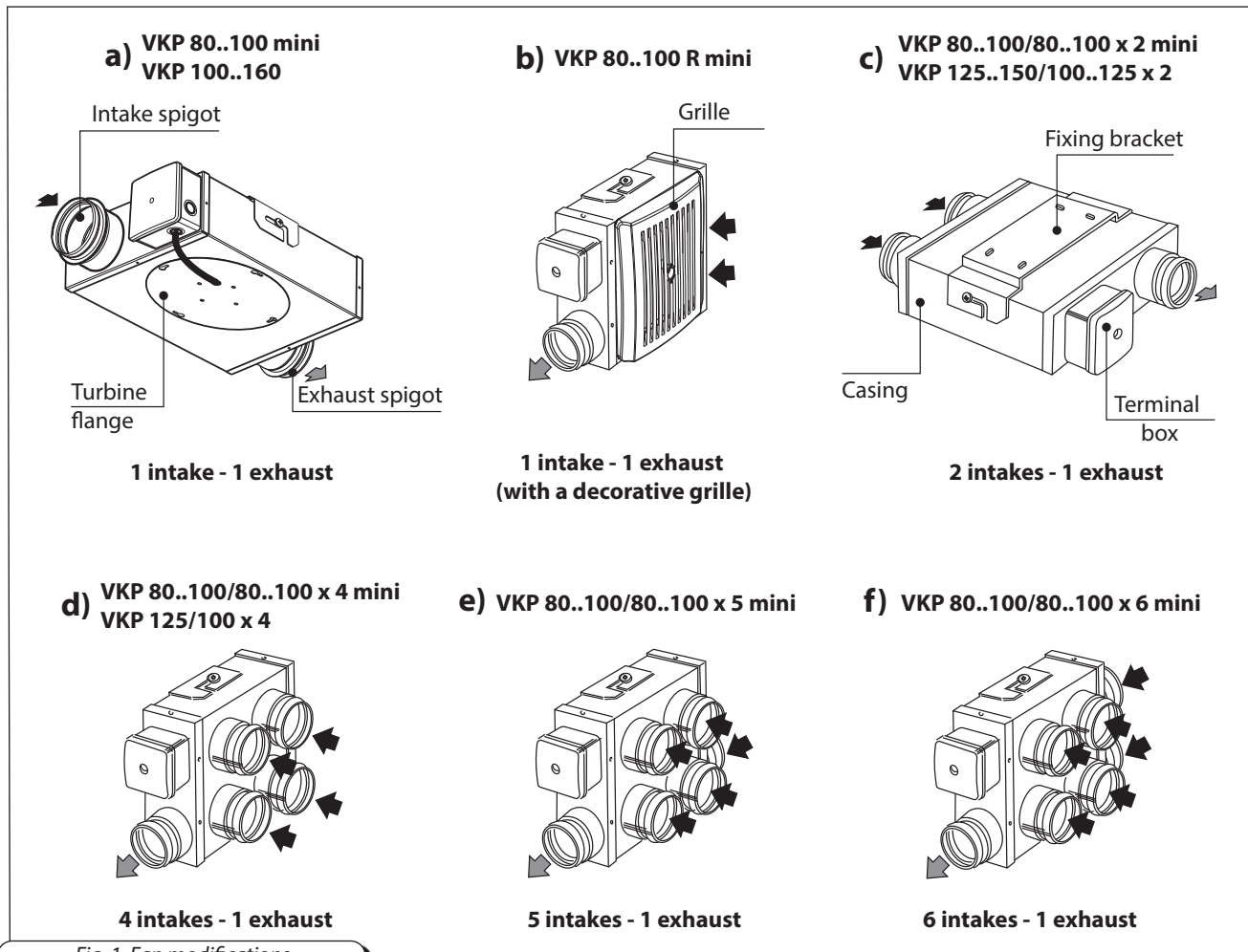

Fig. 1. Fan modifications

The VKP mini fan, Fig. 1, consists of a metal casing with a turbine fixed on a casing flange. The impeller with forward curved blades is located inside of the scroll casing that ends up with the exhaust spigot. The terminal box incorporates an operating and an input capacitor and a terminal block inside is attached to the casing end face. The flange with the turbine and a fixing bracket with mounting slots is screwed to the back or front panel of the fan casing depending on its model.

The VKP fan, consists of a metal casing with a turbine with backward curved blades fixed to a flange, fig. 1. The terminal box with an operating and an input capacitor and a terminal block inside is attached to the casing end face. The flange with the turbine and a fixing bracket with mounting slots is screwed to the back or front panel of the fan casing depending on its model.

VKP mini fans are the three-speed fans.

VKP fans are the single-speed fans.

MOUNTING AND SET-UP

The fan is designed for connection to Ø 80, 100, 125, 150 and 160 mm round air ducts.

After unpacking, prior to mounting:

- read carefully and understand the user's manual and mounting, set-up, operation and maintenance instructions;
- check the fan for possible transportation damages.

Follow the safety requirements during the fan setup and operation.

Mounting:

The fan is suitable both for horizontal (fig. 2 a) and vertical (fig. 2 b) installation.

To reduce air turbulence related pressure losses connect a straight air duct to the fan of the length equal to min. 1 air duct diameter on the intake side and min. 3 air duct diameter on the exhaust side. Do not install filters or any other similar devices at these sections.

While mounting provide enough access for maintenance of the fan.

Table 3. Connection dimensions

Fan type	Dimensions		Fan type	Dimensions		Figure	
	H1	H2		H1	H2		
VKP 80 mini	55	200	VKP 100/80x6 mini	55	200		
VKP 80 R mini			VKP 100/100x2 mini				
VKP 80/80x2 mini			VKP 100/100x4 mini				
VKP 80/80x4 mini			VKP 100/100x5 mini				
VKP 80/80x5 mini			VKP 100/100x6 mini				
VKP 80/80x6 mini			VKP 100				
VKP 100 mini			VKP 125	60			
VKP 100 R mini			VKP 125/100x4				
VKP 100/80x2 mini			VKP 150				
VKP 100/80x4 mini			VKP 150/125x2				250
VKP 100/80x5 mini			VKP 160				

In case of need to plug the fan spigot, first apply some silicone grease on the spigot rubber seal.

- The silicone grease for rubber seals is not supplied with the fan delivery set.
- The plugs are supplied on separate order.

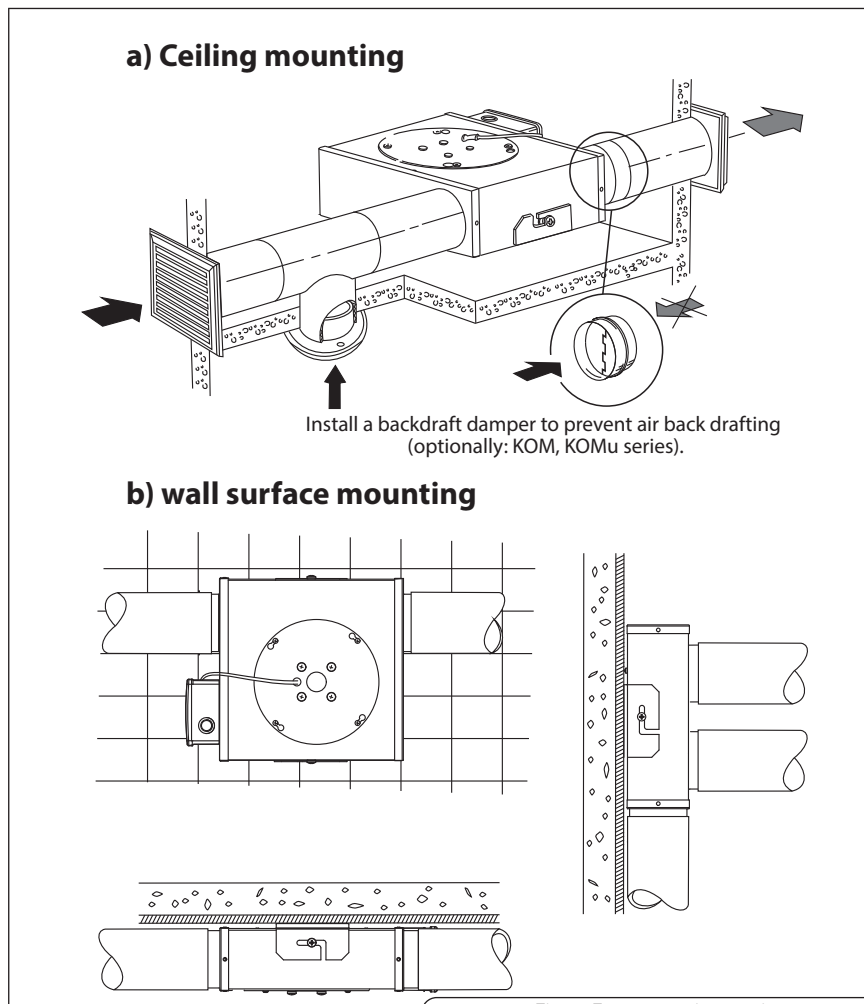
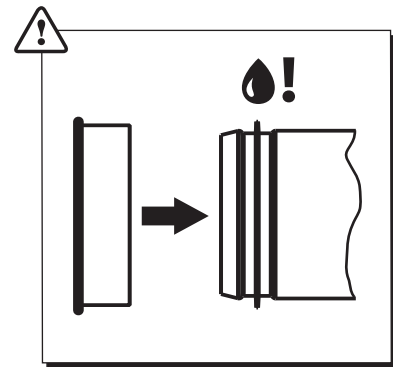

Fig. 2. Fan mounting options

Fan mounting sequence:

- make sure of no power supply to the fan;
- mark the holes for the fixing bracket on the mounting surface (table 3, fig. 3a);
- drill the holes and fix the bracket with matching fasteners, dowels (fig. 3b);
- install the fan on the fixing bracket (fig. 3c);
- tighten the fixing screws (fig. 3d);
- connect the air ducts to the fan spigots (fig. 3e);
- tighten the quick-detachable clamps to fix the air duct to spigot connections (fig. 3f).

Possible connections of the air duct to the VKP XXX/XXXx4 fans are shown in fig. 3 g, 3 h).

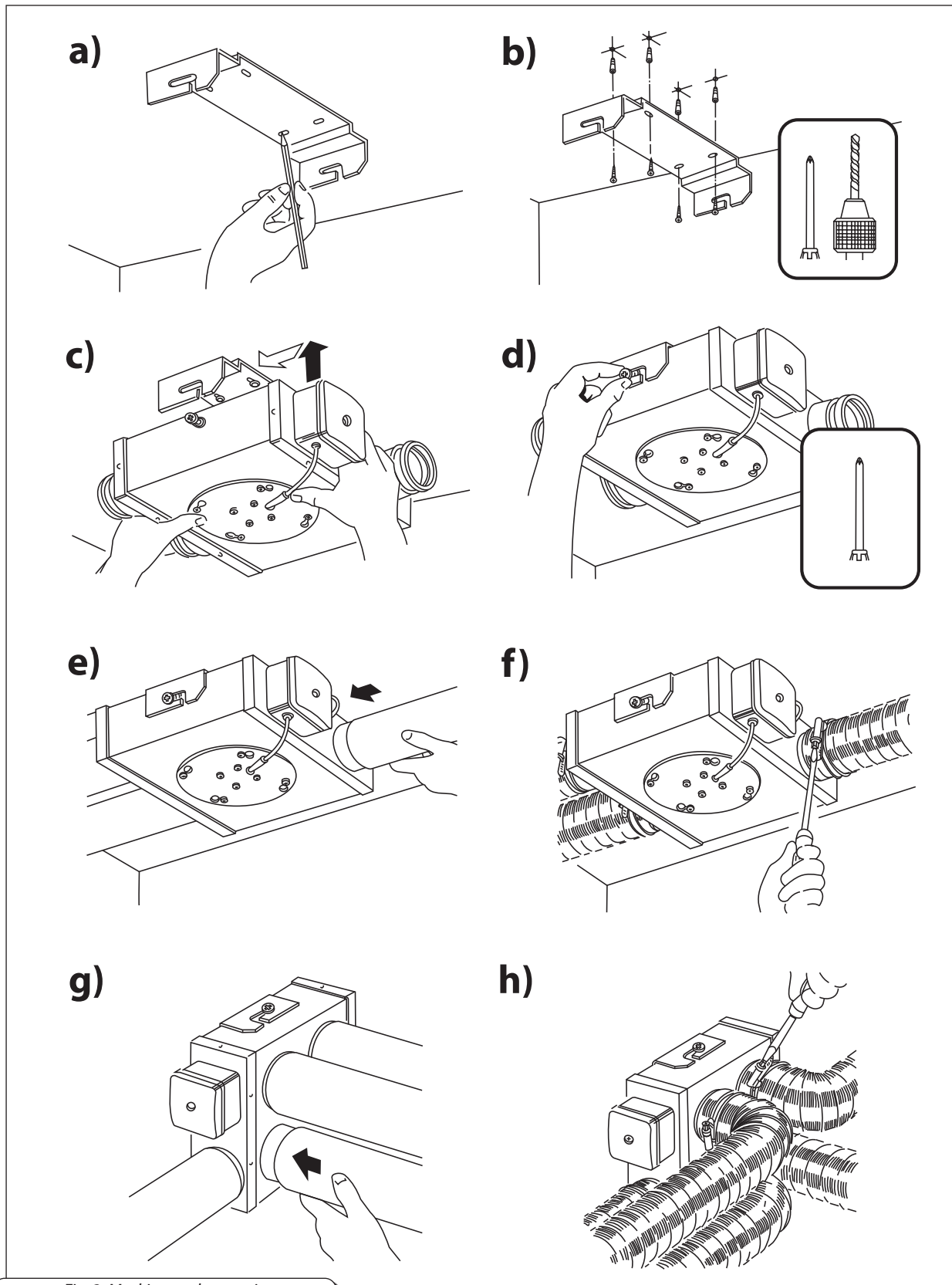

Fig. 3. Marking and mounting

CONNECTION TO POWER MAINS

READ THE USER'S MANUAL BEFORE CONNECTING THE FAN TO POWER MAINS. THE FAN MUST BE CONNECTED TO POWER MAINS BY A QUALIFIED ELECTRICIAN ONLY. THE FAN IS RATED FOR CONNECTION TO ALTERNATING CURRENT POWER SUPPLY WITH VOLTAGE COMPLIANT TO THE TECHNICAL DATA TABLE. MAKE SURE THE POWER CABLE IS NOT PRESSED ANYWHERE. DO NOT TURN THE FAN ON IF THE CABLE IS DAMAGED. NEVER TAKE THE CABLE PLUG WITH WET HANDS OR PULLING THE CABLE. THE RATED ELECTRICAL PARAMETERS OF THE FAN ARE STATED ON THE RATING PLATE. ANY INTERNAL CONNECTION MODIFICATIONS ARE NOT ALLOWED AND RESULT IN VOID WARRANTY.

The fan is designed for connection to single-phase AC 230 V / 50 Hz.

Connect the fan to power mains by means of insulated, durable and thermal-resistant cords (cables, wires). Install an automatic circuit breaker at the external electric input and connect it into the house wireworks. Install the external automatic circuit breaker to enable quick unhampered access to it in case urgent disconnection of the fan is required.

The recommended circuit breaker trip current is 1.0 A and the recommended cable cross section is 0.75 mm². While selecting the cable type consider the maximum allowable cable heating temperature that depends on the wire type, insulation, length and layout way (open wire mounting, channel type or wall-mounted).

Connect the fan to power mains through the terminal block incorporated inside the terminal box on the fan casing in compliance with the fan wiring diagram in fig. 5.

Air flow direction in the system must match the pointer in the fan casing.

The fan electric wiring sequence is show in fig. 4:

- remove the terminal box cover. Route the power cables through the cable entry on the terminal box;
- strip the power wires for 7-8 mm, then insert the wire ends into the respective terminals against insulation stop to the metal part and fix these with screws;
- cover the terminal box.

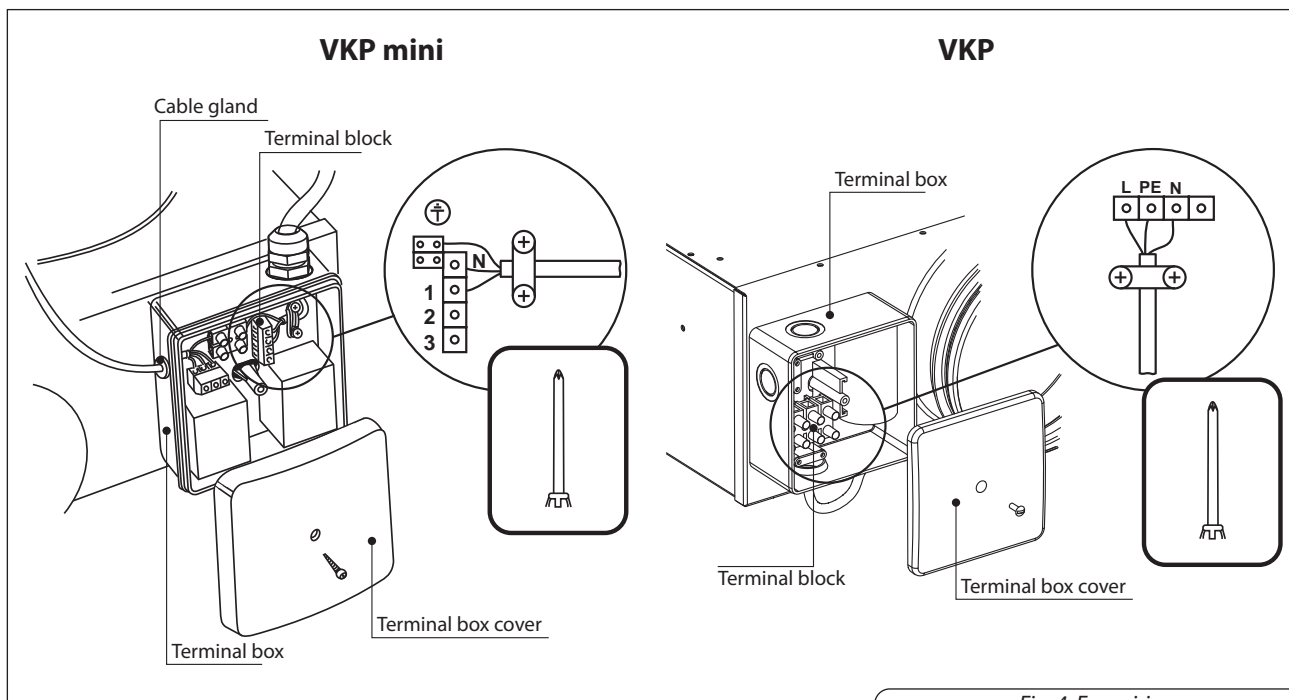
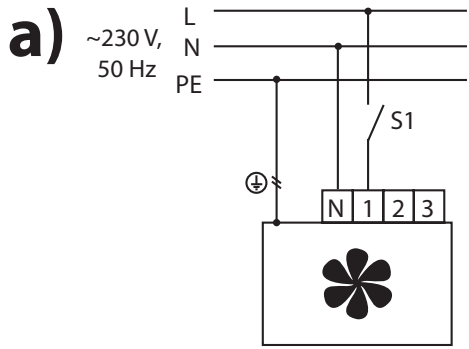
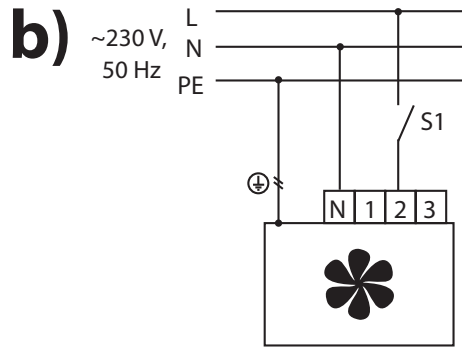

Fig. 4. Fan wiring



Connection of the VKP mini fan at first speed



Connection of the VKP mini fan at second speed

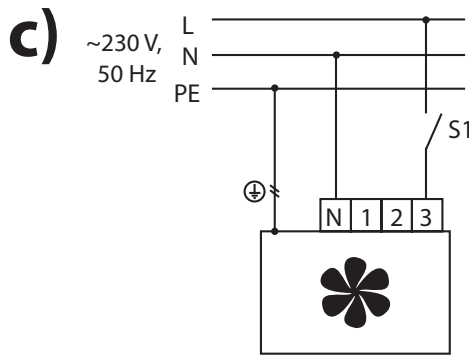

Connection of the VKP mini fan at third speed

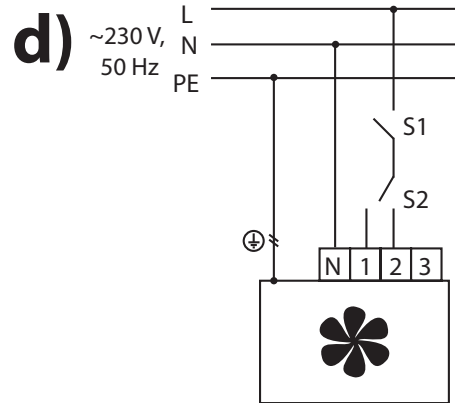

Connection of the VKP mini fan at first or second speed. The speed changeover is carried out with the external switch S2. S1 - fan on/off switch.

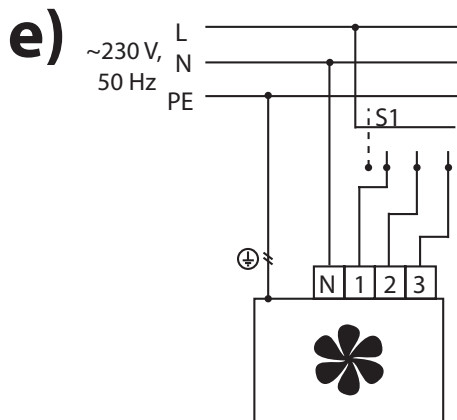

Connection of the VKP mini fan at first, second or third speed S1 - fan on/off switch and speed switch

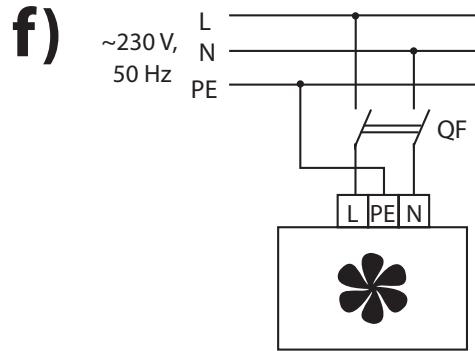

VKP fan connection

Fig. 5. Wiring diagrams

MAINTENANCE

Disconnect the fan from power mains prior to maintenance and servicing operations and make sure that the moving parts have come to a full stop.

The fan maintenance means regular cleaning of the fan surfaces of dust and dirt.

Clean the impeller blades thoroughly once in 6 months as follows:

- cut off power supply to the fan, fig. 6 a;
 - loosen four screws, fig. 6 b;
 - remove the flange with the turbine from the casing, fig. 6 c;
 - clean the impeller blades using a dry brush or a vacuum cleaner, fig. 6 d;
- Perform all the operations in the reverse order after cleaning.

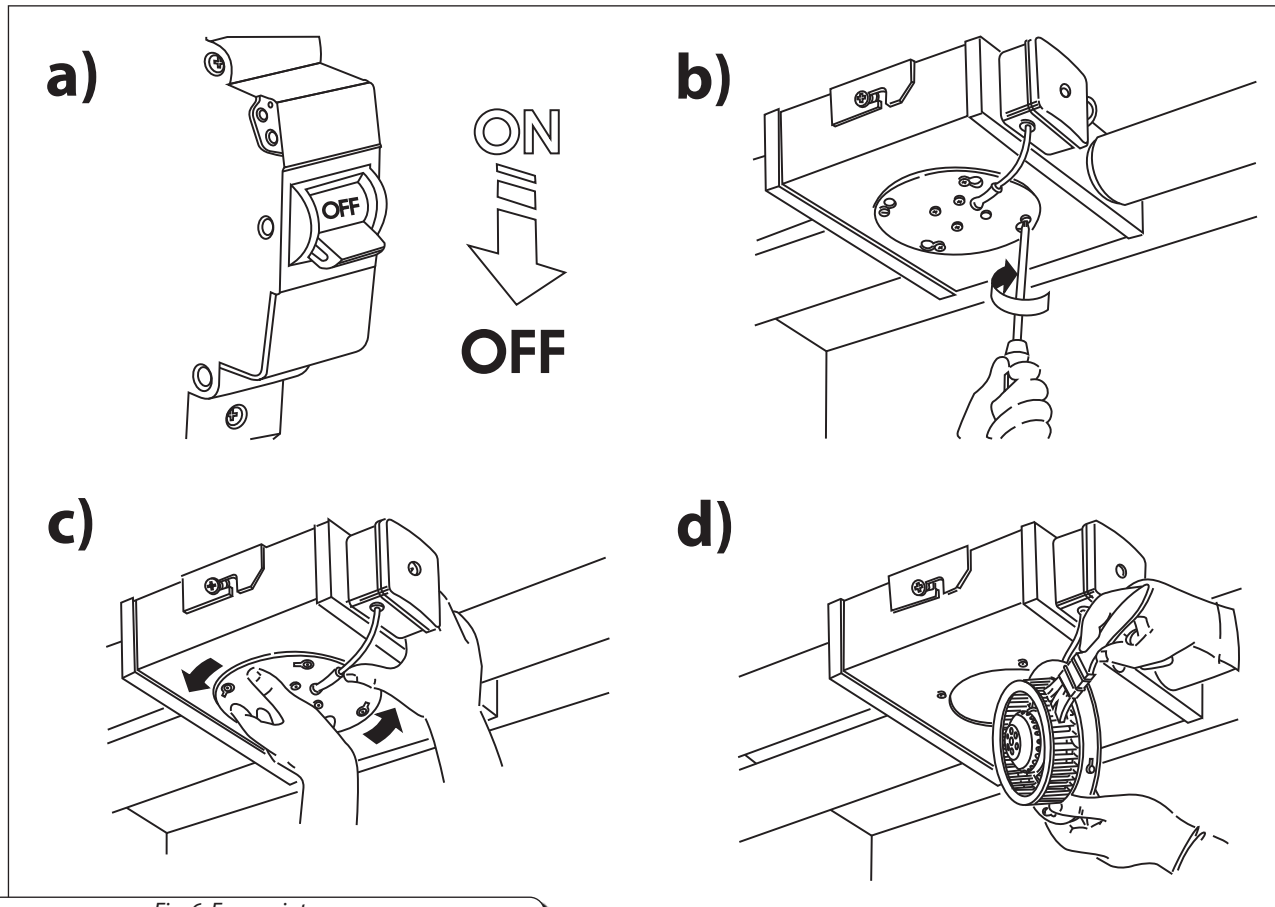

Fig. 6. Fan maintenance



TROUBLESHOOTING
Table 4. Troubles and troubleshooting

Problem	Possible reasons	Fault handling
The fan does not start	No power supply.	Make sure of correct power supply, otherwise troubleshoot a connection error.
	Motor jam.	Turn the fan off. Troubleshoot the motor jamming. Restart the fan.
Automatic circuit breaker tripping during the fan start	Overcurrent as a result of short circuit.	Turn the fan off. Contact the service centre.
Noise, vibration	The fan impeller is soiled.	Clean the fan impeller.
	Loose screw tightening.	Check the screw connection and tighten the screws if required.

STORAGE AND TRANSPORTATION RULES

Store the fan in the manufacturer's original packing box in a dry ventilated premise at the temperatures from +10°C up to + 40°C.

Storage environment must not contain aggressive vapours and chemical mixtures provoking corrosion, insulation and sealing deformation.

Use hoist machinery for handling and storage operations to prevent the fan damage in consequence of falling or excessive oscillation. Fulfil the handling requirements applicable for the applicable freight type.

Transportation with any vehicle type is allowed provided that the fan is protected against mechanical and weather damage.

Avoid any mechanical shocks and strokes during handling operations.

MANUFACTURER'S WARRANTY

The manufacturer hereby warrants normal operation of the fan over the period of 24 months from the retail sale date provided the user's observance of the transportation, storage, installation and operation regulations.

Should any malfunctions occur during the fan operation through the manufacturer's fault during the warranty period the user is entitled to elimination of faults by means of warranty repair performed by the manufacturer.

The warranty repair includes work specific to elimination of faults in the fan operation to ensure its intended use by the user within the warranty period. The faults are eliminated by means of replacement or repair of the complete unit or the faulty part thereof.

The warranty repair does not include:

- Routine maintenance;
- Fan installation / dismantling;
- Fan setup.

To benefit from warranty repair the user must provide the fan, the user's manual with stamped sale date and the payment document certifying the purchase.

The fan model must comply with the one stated in the user's manual.

Contact your Seller for warranty service.**The manufacturer's warranty does not apply to the following cases:**

- User's failure to provide the fan with the entire delivery package as stated in the user's manual or with missing component parts previously dismantled by the user;
- Mismatch of the fan model and make with the respective details stated on the fan packing and in the user's manual;
- User's failure to ensure timely technical maintenance of the fan;
- External damage to the casing (excluding external modifications of the fan as required for its installation) and the internal components of the fan;
- Alteration of the fan design or engineering changes of the fan;
- Replacement and use of the fan assemblies, parts and components not approved by the manufacturer;
- Other use of the fan than intended;
- User's violation of the fan installation regulations;
- User's violation of the fan management regulations;
- Fan connection to the power mains with a voltage different from the one stated in the user's manual;
- Fan breakdown due to voltage surges in the power mains;
- User's discretionary repair of the fan;
- Fan repair performed by any persons without the manufacturer's authorization;
- Expiry of the fan warranty period;
- User's violation of the established regulations specific to the fan transportation;
- User's violation of the fan storage regulations;
- Wrongful acts against the fan committed by third persons;
- Fan breakdown due to circumstances of insuperable force (fire, flood, earthquake, war, hostilities of any kind, or blockade);
- Missing seals if provided by the user's manual;
- Failure to provide the user's manual with the sale date stamp;
- Missing payment document certifying the fan purchase.



FOLLOWING THE REGULATIONS STIPULATED HEREIN WILL ENSURE A LONG AND TROUBLE-FREE OPERATION OF THE FAN.



USERS' CLAIMS SHALL BE SUBJECT TO REVIEW ONLY UPON PRESENTATION OF THE FAN, THE PAYMENT DOCUMENT AND THE USER'S MANUAL WITH THE SALE DATE STAMP.

ACCEPTANCE CERTIFICATE

Product Type	Inline fan
Model	VKP
Serial Number	
Manufacturing Date	
is recognized as serviceable. We hereby declare that the product complies with the essential protection requirements of Electromagnetic Council Directive 2004/108/EC, 89/336/EEC and Low Voltage Directive 2006/95/EC, 73/23/EEC and CE-marking Directive 93/68/EEC on the approximation of the laws of the Member States relating to electromagnetic compatibility. This certificate is issued following test carried out on samples of the product referred to above.	
Quality Inspector's Stamp	

SELLER'S INFORMATION

Shop name	
Address	
Telephone	
E-mail	
Sales date	
This is to certify delivery of the complete fan with the user's manual. The warranty terms are acknowledged and accepted.	
Customer's signature	

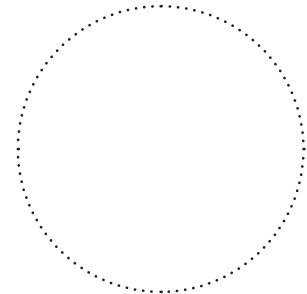

Seller's seal

CONNECTION CERTIFICATE

The inline fan VKP _____ has been connected to power mains pursuant to the requirements stated in the present user's manual.	
Company name	
Address	
Telephone	
Installation technician's full name	
Installation date:	Signature:
This is to certify that the works specific to the fan installation have been performed in accordance with all the applicable provisions of local and national construction, electrical and technical codes and standards. The fan operates normally as intended by the manufacturer.	
Signature:	

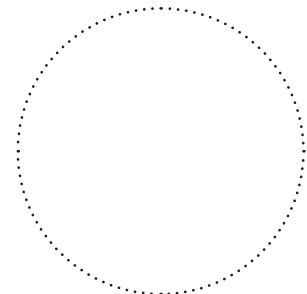

Installation technician's company seal

