

CLAMPS

101110E-10
 T-CLAMP 1 1/4" X 1 1/4"
 (BOX OF 10)



101120G-10
 T-CLAMP 1 1/16" X 1 5/8"
 (BOX OF 10)



101130-C
 CORNER CLAMP - 1 5/8"

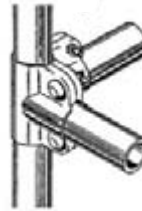

101140H-10
 WALL FLANGE CLAMP - 1 5/8"
 (BOX OF 10)



101150D-5
 2-WAY THRU CLAMP - 1 5/8"
 (BOX OF 5)



101180-B
 3-WAY CLAMP - 1 5/8"



101170-I
 4-WAY CLAMP - 1 5/8"

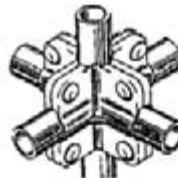

101165-10
 2 PC. X-OVER CLAMP - 1 5/8"
 (BOX OF 10)

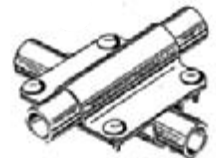

101166-10
 X-OVER CLAMP - 1 5/8" X 2 3/8"
 (BOX 10)

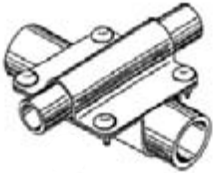

101167-10
 X-OVER CLAMP - 2 3/8"
 (BOX OF 10)

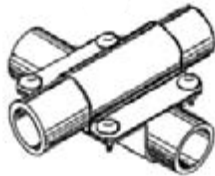

101160X-10
 1 PC. X-OVER CLAMP - 1 5/8"
 (BOX OF 10)



101190U-10
 2-BOLT HEADRAIL CLAMP
 (BOX OF 10)



101195U-10
 1 BOLT HEADRAIL CLAMP
 (BOX OF 10)



101175-1
 2 3/8" OD T-CLAMP (1 BOLT)
101175-1PK
 2 3/8" OD T-CLAMP (1 BOLT)(BOX OF 10)



101175-3
 2 3/8" OD T-CLAMP (3 BOLT)
101175-3PK
 2 3/8" OD T-CLAMP (3 BOLT)(BOX OF 10)



101175-C
 2 3/8" OD CORNER (1 BOLT)
101175-CPK
 2 3/8" OD CORNER (1 BOLT)(BOX OF 10)

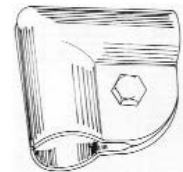

1011540-10
 X-OVER 3.5" X 2 3/8" BX/10

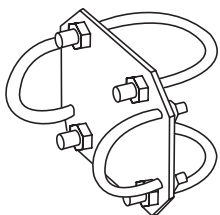

101169-10
 HD X-OVER (U-BOLT)
 2 3/8" X 1 5/8" (BOX OF 10)

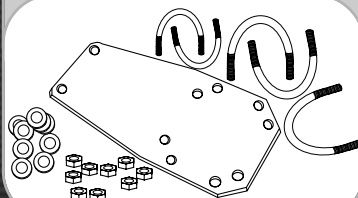

2070994-20
 X-OVER 7/8" X 1 1/16" OD
 (BOX OF 20)

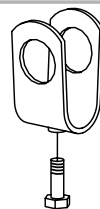

MISCELLANEOUS U-BOLTS
 SEE CLAMPS P1

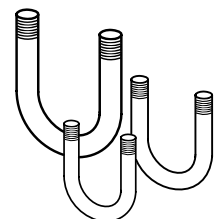

WEDGE OR T-BOLT (CONCRETE)

2100125-20
WIDE WEDGE BOLT (BOX OF 20)

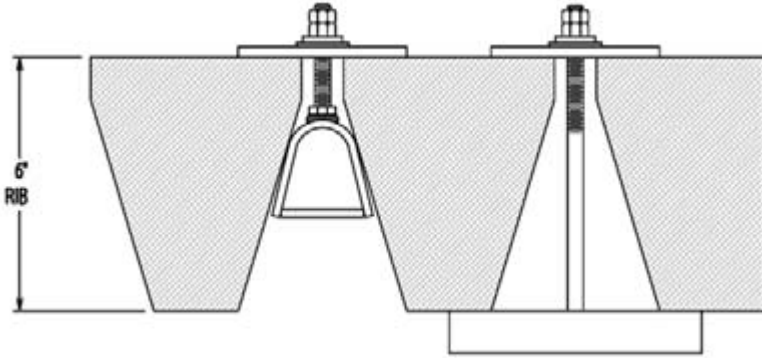

2100121-20
7 1/4" LG. T-BOLT (BOX OF 20)

2100225-20
NARROW WEDGE BOLT (BOX OF 20)

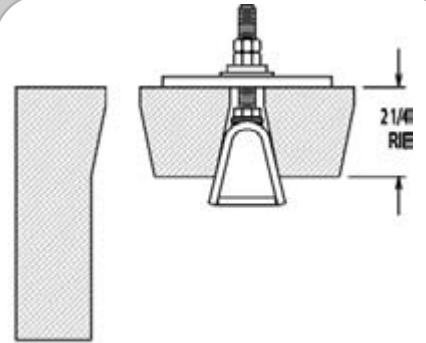

T-BOLTS

2099220
PKG OF 4 T-BOLTS (BLOCK & WASHER)

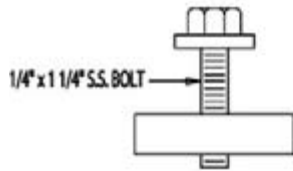

2100120-120
T-BOLT 2" LG. (BOX OF 20)

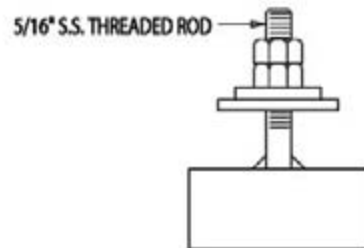

TOPLOCK J-BOLTS

2100135-20
J-BOLT 5 1/4" LG. (BOX OF 20)

